

Modular relief valves type HMP, HM, KM

ISO 4401 sizes 06 and 10

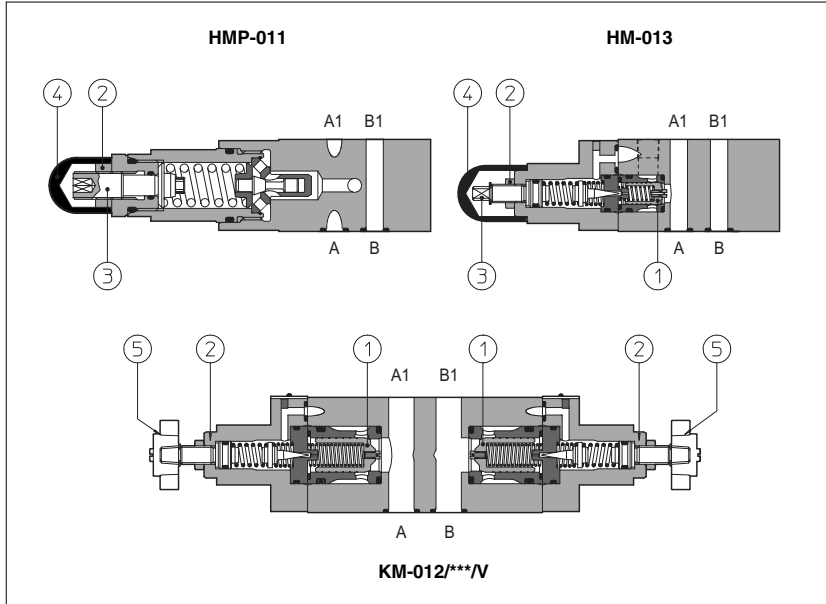

HMP are direct operated pressure relief valves.
HM and KM are double stage pressure relief valves with balanced poppet ①.

The pressure adjustment is operated by loosening the locking nut ② and turning the screw ③ protected by cap ④. Optional versions with setting adjustment by handwheel ⑤ instead of the screw are available on request. Clockwise rotation increases the pressure.

HMP = ISO 4401 size 06 interface; max flow: 35 l/min; max pressure up to 350 bar.

HM = ISO 4401 size 06 interface; max flow: 60 l/min; max pressure up to 350 bar.

KM = ISO 4401 size 10 interface; max flow: 120 l/min; max pressure up to 350 bar.

Valves designed to operate in hydraulic systems with hydraulic mineral oil or synthetic fluid having similar lubricating characteristics.

1 MODEL CODE

HM - **011** / **210** **/V** ****** **/***

<p>Modular pressure relief valve size:</p> <p>HMP = 06</p> <p>HM = 06</p> <p>KM = 10</p>	<p>Options:</p> <p>/V = setting adjustment by handwheel instead of a grub screw protected by cap</p> <p>Only for HMP:</p> <p>/R = reduced leakage for special applications</p> <p>/VF = regulating knob</p> <p>/VS = regulating knob with safety locking</p>	<p>Synthetic fluids:</p> <p>WG = water glycol</p> <p>PE = phosphate ester</p>
<p>Configuration, see section 2</p>	<p>Pressure range</p> <p>for HMP:</p> <p>50 = 2÷ 50 bar</p> <p>100 = 3÷100 bar</p> <p>210 = 10÷210 bar</p> <p>350 = 15÷350 bar</p>	<p>Series number</p>
<p>011 = single; acting on port P, discharge to port T</p> <p>012 = double, acting on ports A and B, discharge to port T</p> <p>013 = single, acting on port A, discharge to port T</p> <p>014 = single, acting on port B, discharge to port T</p> <p>015 = double, acting on ports A and B, with the relieved pressure cross-discharged</p>	<p>for HM and KM:</p> <p>50 = 4÷ 50 bar</p> <p>100 = 5÷100 bar</p> <p>210 = 5÷210 bar</p> <p>350 = 5÷350 bar</p>	

2 HYDRAULIC CHARACTERISTICS

Hydraulic configuration

Valve model		HMP	HM	KM
Max flow	[l/min]	35	60	120
Pressure range	[bar]	2÷50; 3÷100; 10÷210; 15÷350	4÷50; 5÷100; 5÷210; 5÷350	

3 MAIN CHARACTERISTICS OF MODULAR PRESSURE RELIEF VALVE TYPE HMP, HM, KM

Assembly position / location	Any position
Subplate surface finishing	Roughness index $\sqrt{0.4}$, flatness ratio 0,01/100 (ISO 1101)
Ambient temperature	-20°C to +70°
Fluid	Hydraulic oil as per DIN 51524 ... 535; for other fluids see section 1
Recommended viscosity	15 ÷ 100 mm ² /s at 40°C (ISO VG 15 ÷ 100)
Fluid contamination class	ISO 19/16, achieved with in line filters at 25 µm value and $\beta_{25} \geq 75$ (recommended)
Fluid temperature	-20°C +60°C (standard and /WG seals) -20°C +80°C (/PE seals)

4 REGULATED PRESSURE VERSUS FLOW DIAGRAMS (Based on mineral oil ISO VG 46 at 50°C)

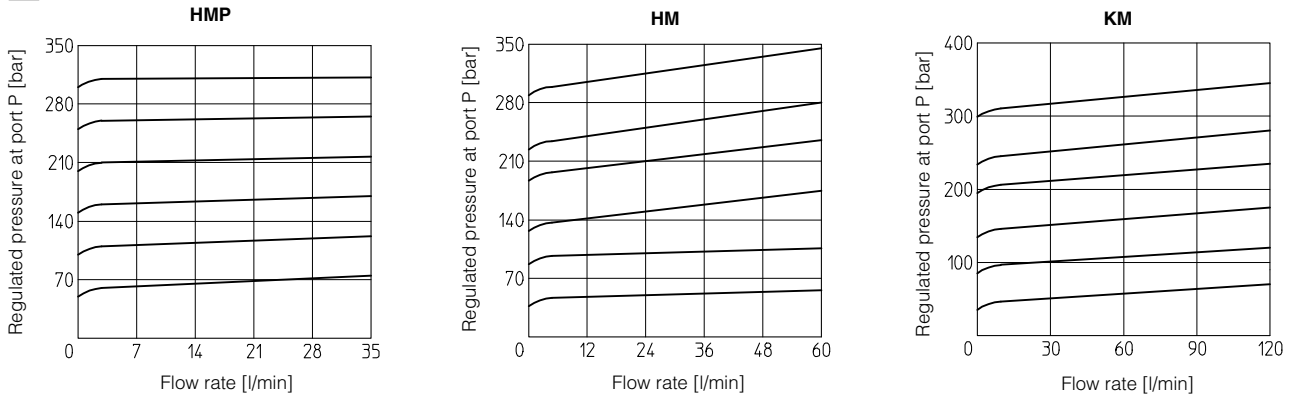

5 MINIMUM PRESSURE VERSUS FLOW DIAGRAMS (Based on fluid viscosity of 25 mm²/s at 40°C)

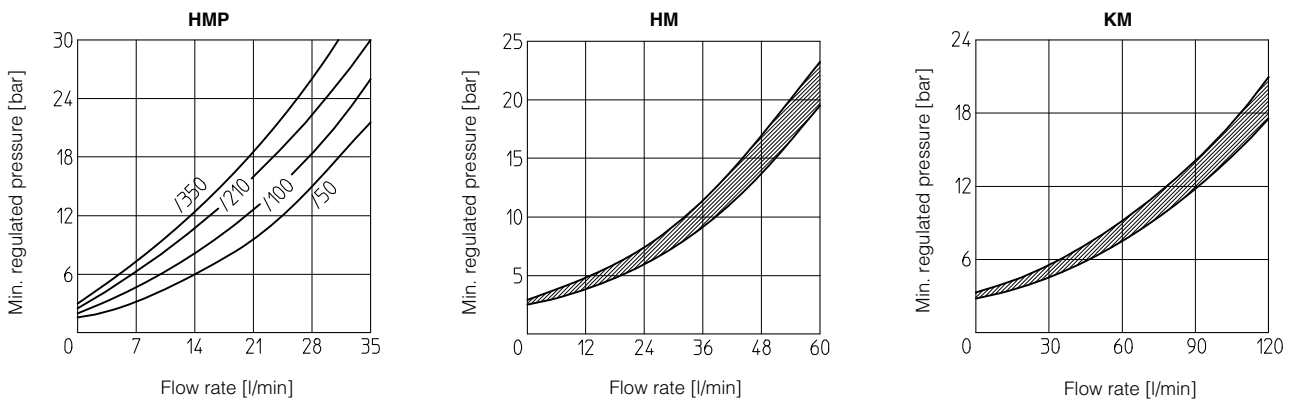

6 INSTALLATION DIMENSIONS OF HMP VALVES [mm]

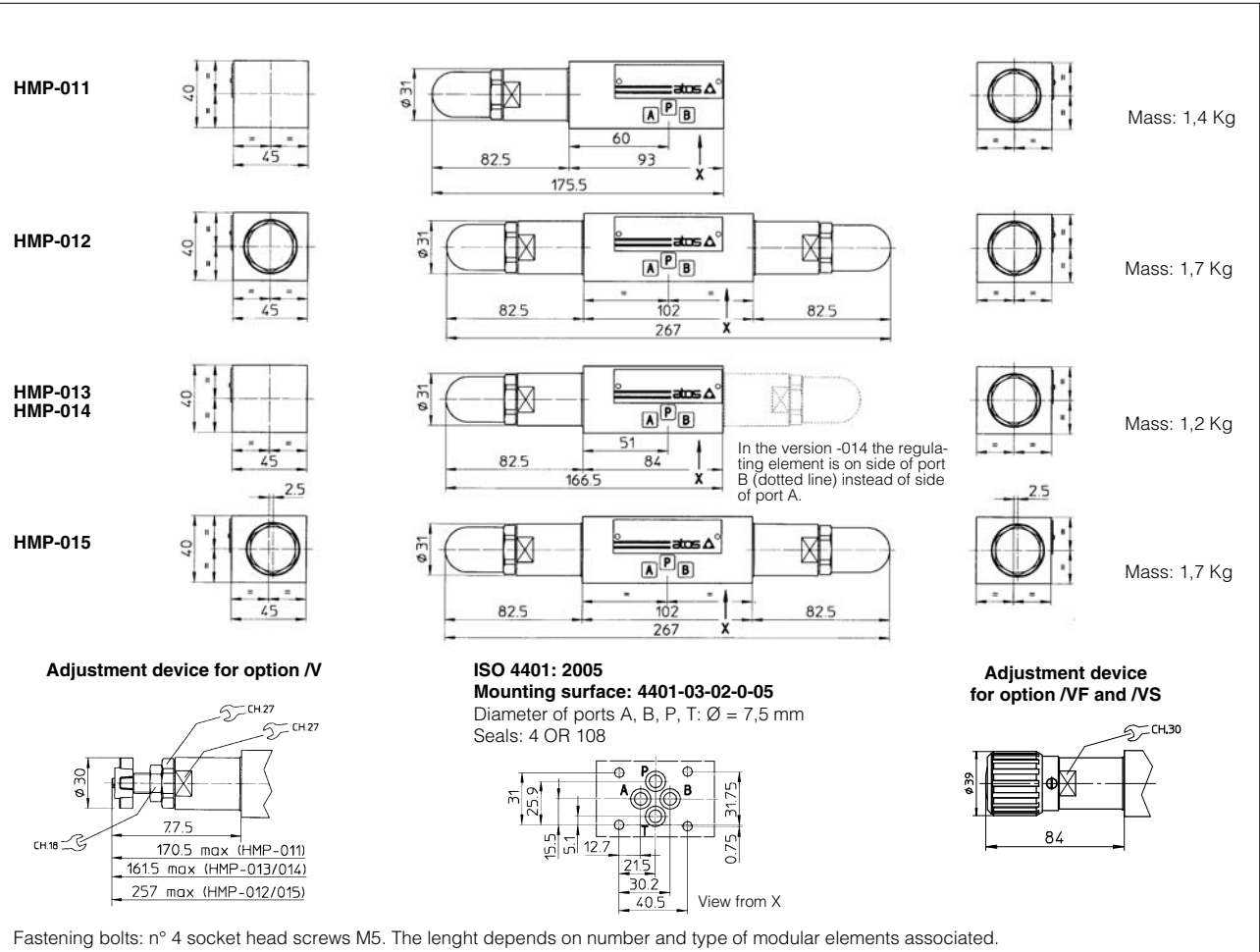

7 INSTALLATION DIMENSIONS OF HM VALVES [mm]

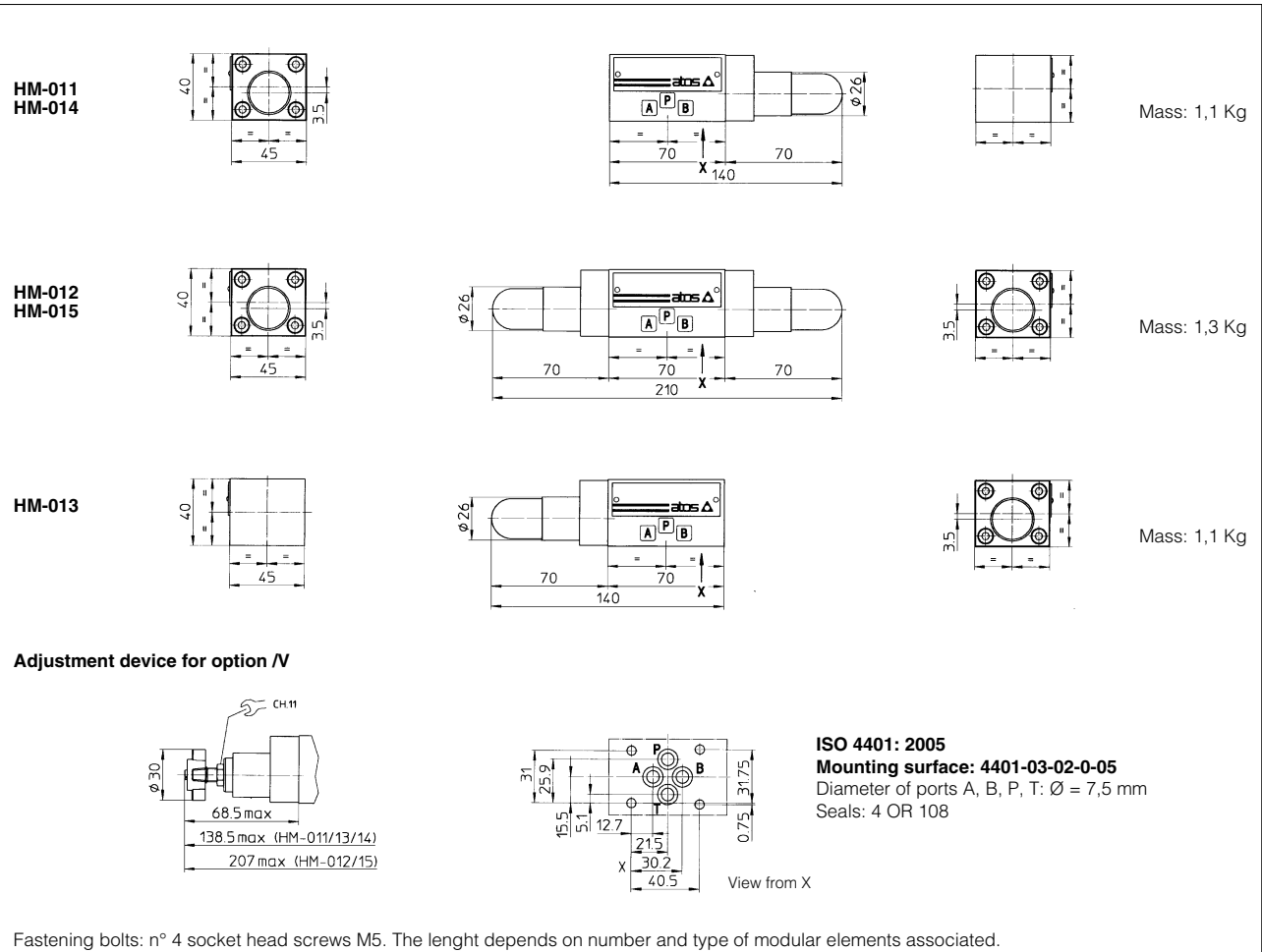

8 INSTALLATION DIMENSIONS OF KM VALVES [mm]

KM-011

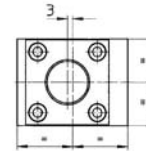
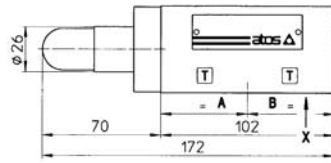
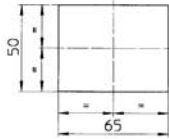

Mass: 2,5 Kg

KM-012

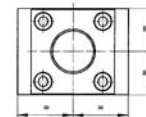
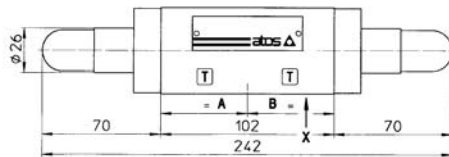
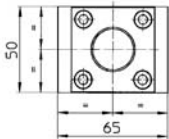

Mass: 2,8 Kg

KM-013

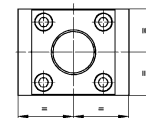
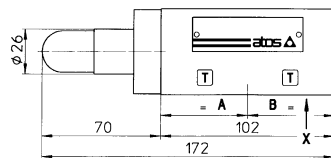
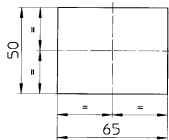

Mass: 2,5 Kg

KM-014

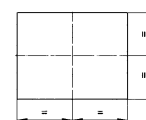
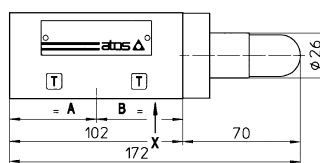
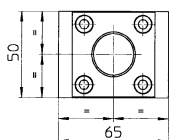

Mass: 2,5 Kg

KM-015

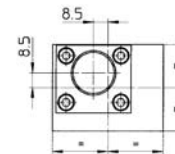
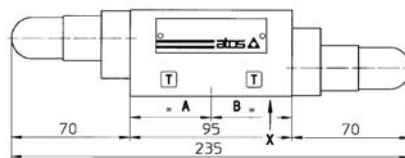
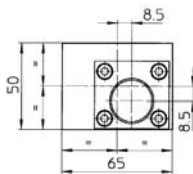

Mass: 2,5 Kg

Adjustment device for option /V

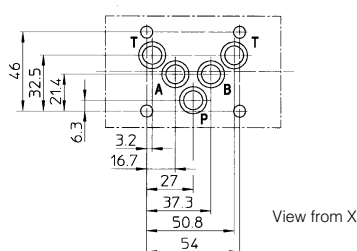
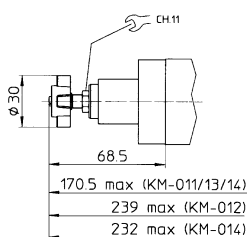

ISO 4401: 2005

Mounting surface: 4401-05-04-0-05

Diameter of ports A, B, P, T: $\phi = 11,2$ mm

Seals: 5 OR 2050

Fastening bolts: n° 4 socket head screws M6. The length depends on number and type of modular elements associated.